



Thank you for purchasing our product, an ideal radio system for beginners or experienced users.

In order to ensure your safety, and the safety of others, read this manual carefully before using this product. If you encounter any problem during use, refer to this manual first. If the problem persists, contact your local dealer or visit our service and support website :

www.flysky-cn.com



Contents

1. Safety	1
1.1 Safety Symbols	1
1.2 Safety Guide	1
2. Introduction	2
2.1 System Features	2
2.2 Transmitter Overview	3
2.3 Receiver Overview	4
2.3.1 Status Indicator	4
2.3.2 Connectors	4
2.3.3 Gyroscope Calibration	4
2.4 Antenna Use	5
3. Getting Started	6
3.1 Transmitter Battery Installation	6
3.2 Connecting the Receiver and Servos	6
4. Operation Instructions	7
4.1 Power On	7
4.2 Binding	7
4.3 Transmitter LED Status Indicator	8
4.4 Calibration (STK.CAL)	8
4.5 Factory Reset	8
4.6 Power Off	8
5. System Interface	9
6. Function Settings	10
6.1 Model (MODEL)	10
6.2 Name (NAME)	10
6.3 Reverse(REV)	10
6.4 End Point Adjust (EPA)	11
6.5 Sub Trim (SUB-TR)	11
6.6 Dual/Rate (D/R)	11
6.7 Exponential (EXP)	12
6.8 A.B.S. (ABS)	12
6.9 Trim (TRIM)	13
6.10 Failsafe (F.SAFE)	13
6.11 Crawl (CRAW)	14
6.12 S.V.C. (SVC)	14
7. Product Specifications	17
7.1 Transmitter Specifications(FS-GT5)	17
7.2 Receiver Specifications(FS-BS6)	17
8. Package Contents	18
9. Certification	19
9.1 DoC Declaration	19
9.2 CE Warning	19
9.3 Appendix 1 FCC Statement	19
10. Environmentally friendly disposal	20

1. Safety

1.1 Safety Symbols

Pay close attention to the following symbols and their meanings. Failure to follow these warnings could cause damage, injury or death.

 Danger	• Not following these instructions may lead to serious injuries or death.
 Warning	• Not following these instructions may lead to major injuries.
 Attention	• Not following these instructions may lead to minor injuries.

1.2 Safety Guide



Prohibited



Mandatory



- **Do not use the product at night or in bad weather like rain or thunderstorm. It can cause erratic operation or loss of control.**
- **Do not use the product when visibility is limited.**
- **Do not use the product on rain or snow days. Any exposure to moisture (water or snow) may cause erratic operation or loss of control.**
- **Interference may cause loss of control. To ensure the safety of you and others, do not operate in the following places:**
 - Near any site where other radio control activity may occur
 - Near power lines or communication broadcasting antennas
 - Near people or roads
 - On any body of water when passenger boats are present
- **Do not use this product when you are tired, uncomfortable, or under the influence of alcohol or drugs. Doing so may cause serious injury to yourself or others.**
- **The 2.4GHz radio band is limited to line of sight. Always keep your model in sight as a large object can block the RF signal and lead to loss of control.**
- **Never grip the transmitter antenna during operation. It significantly degrades signal quality and strength and may cause loss of control.**
- **Do not touch any part of the model that may generate heat during operation, or immediately after use. The engine, motor or speed control, may be very hot and can cause serious burns.**



- **Misuse of this product may lead to serious injury or death. To ensure the safety of you and your equipment, read this manual and follow the instructions.**
- **Make sure the product is properly installed in your model. Failure to do so may result in serious injury.**
- **Make sure to disconnect the receiver battery before turning off the transmitter. Failure to do so may lead to unintended operation and cause an accident.**
- **Ensure that all motors operate in the correct direction. If not, adjust the direction first.**
- **Make sure the model stays within the systems maximum range to prevent loss of control.**





Digital Proportional Radio Control System **FS-GT5**

2. Introduction

This product uses the 2.4GHz Second Generation AFHDS 2A protocol. The FS-GT5 and FS-BS6 constitute a 6 channel gyro stabilised system compatible with model cars, boats and other models.

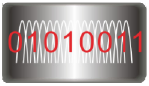
2.1 System Features

The AFHDS 2A (Automatic Frequency Hopping Digital System Second Generation) developed and patented by FLYSKY is specially developed for all radio controlled models. Offering superior protection against interference while maintaining lower power consumption and high reliable receiver sensitivity, FLYSKY's AFHDS technology is considered to be one of the leaders in the RC market today.

	Multi-channel Hopping Frequency This systems bandwidth ranges from 2.408GHz to 2.475GHz. This band is divided in 140 channels. Each transmitter hops between 16 channels (32 for Japanese and Korean versions) in order to reduce interference from other transmitters.
	Omni-directional Gain Antenna The high efficiency Omni-directional high gain antenna cuts down on interference, while using less power and maintaining a strong reliable connection.
	Unique ID Recognition System Each transmitter and receiver has it's own unique ID. Once the transmitter and receiver have been paired, they will only communicate with each other, preventing other systems accidentally connecting to or interfering with the systems operation.
	Low Power Consumption The system is built using highly sensitive low power consumption components, maintaining high receiver sensitivity, while consuming as little as one tenth the power of a standard FM system, dramatically extending battery life.

2.2 Transmitter Overview

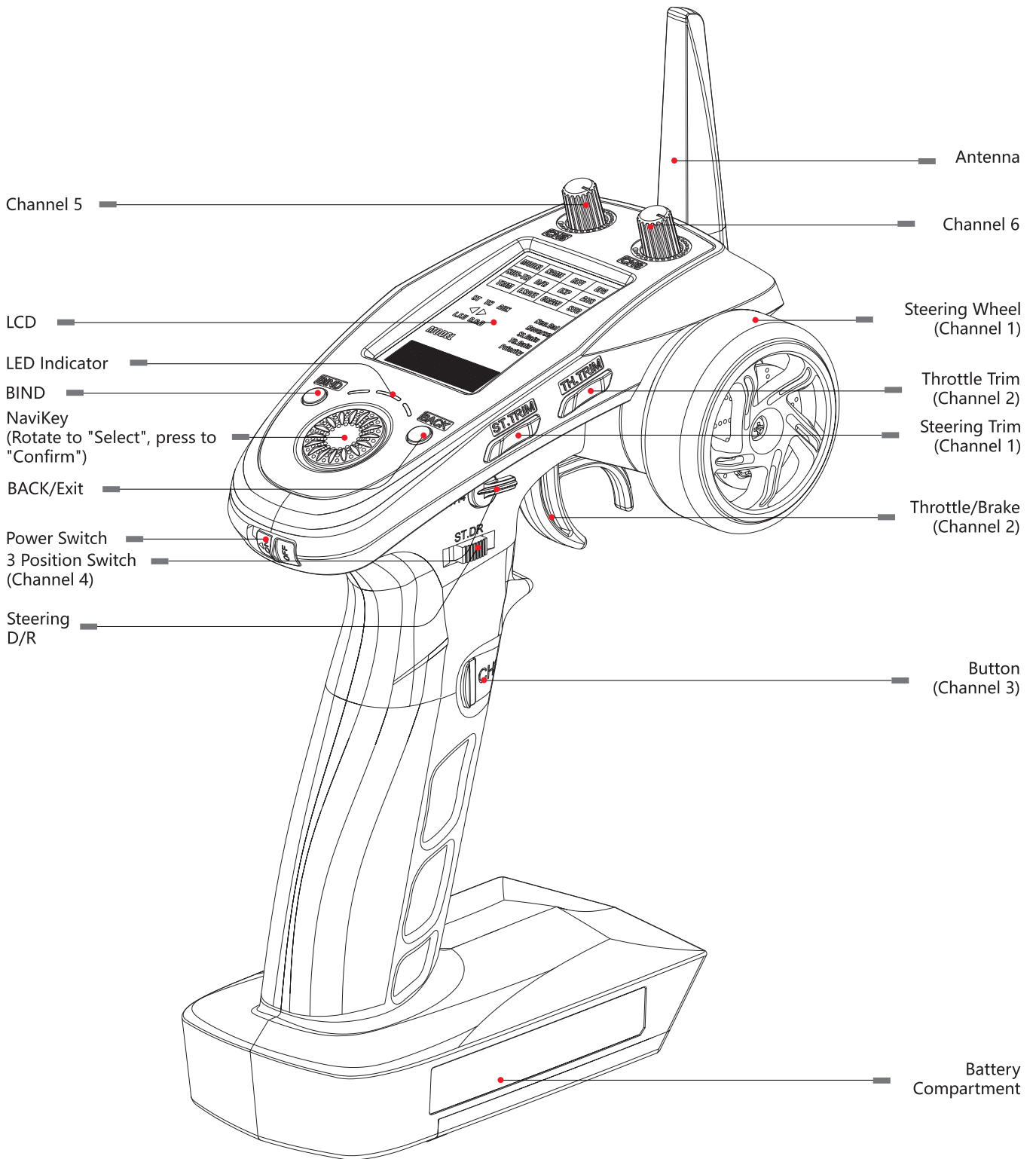

- For more information please refer to [6. Function Settings].

2.3 Receiver Overview

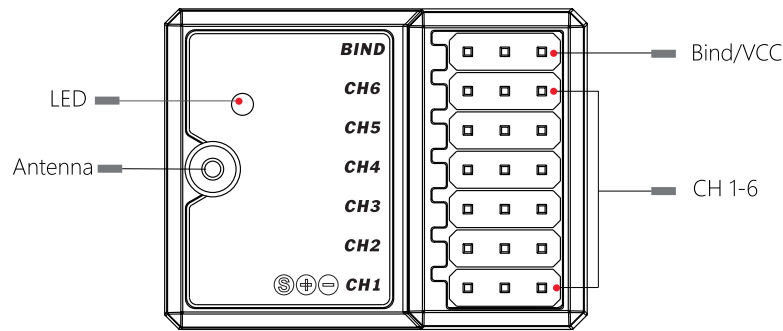

2.3.1 Status Indicator

The status indicator is used to indicate the power and working status of the receiver.

- Off: The power is not connected.
- Lit in red: The receiver is on and working.
- Flashing quickly: The receiver is binding.
- Flashing slowly: The bound transmitter is off or signal is lost.

2.3.2 Connectors

Used to connect to the model and servos.

The FS-BS6 receiver has a gyroscope SVC function that can be used to improve handling.

2.3.3 Gyroscope Calibration

The gyroscope has been calibrated at the factory however if it needs to be recalibrated follow these steps :

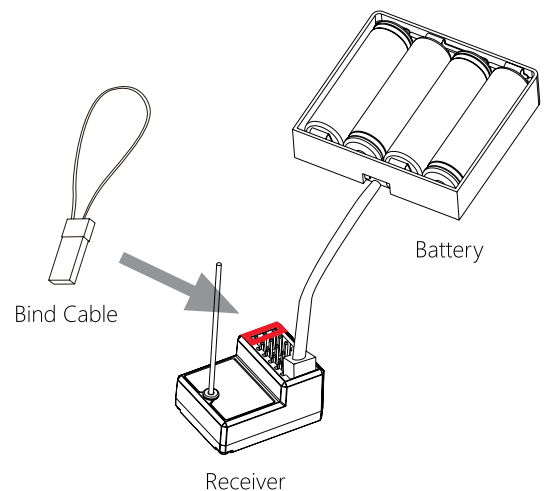

Calibration :

1. Turn off the transmitter and insert power into channel 1 (Not the BIND port)
 - The receivers LED should start to flash slowly.
2. Place the receiver on a flat horizontal surface, make sure it can't move.
3. Insert the bind cable into the bind port. The receivers LED should start to flash rapidly 3 times then return to the previous flash speed if the calibration has been successful.



2.4 Antenna Use

Do not point the antenna directly at the model.



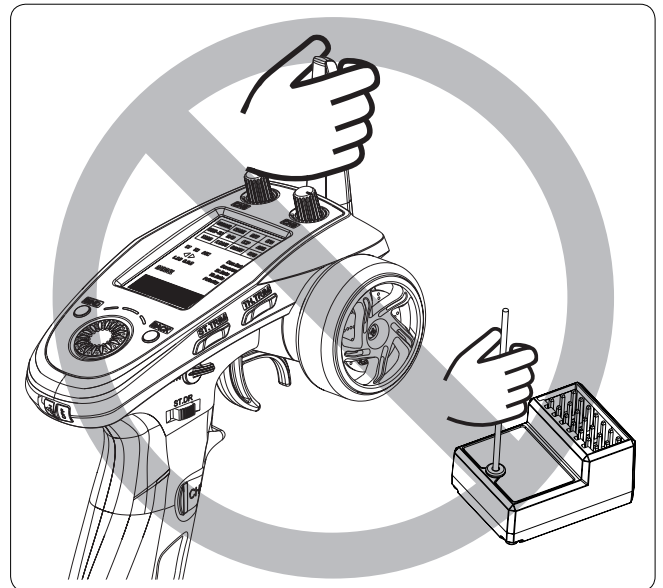
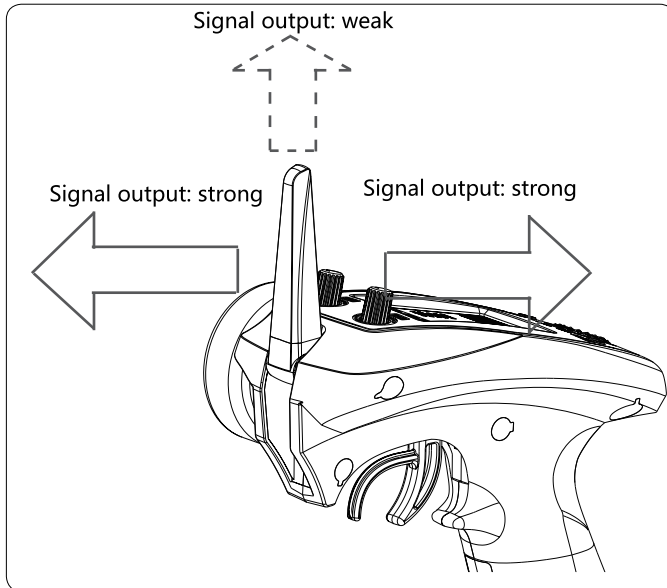



 Note	<ul style="list-style-type: none">• Never grip the transmitter antenna during operation. It significantly degrades the RF signal quality and strength and may cause loss of control.
 Caution	<ul style="list-style-type: none">• For best signal quality, ensure that the receiver is mounted away from motors or metal parts.
 Caution	<ul style="list-style-type: none">• Do not pull or tie the receiver antenna into a knot or tie it to the steering bar.



3. Getting Started

Before operation, install the battery and connect the system as instructed below.

3.1 Transmitter Battery Installation

 Danger	• Only use specified battery (X4 AA batteries).
 Danger	• Do not open, disassemble, or attempt to repair the battery.
 Danger	• Do not crush/puncture the battery, or short the external contacts.
 Danger	• Do not expose to excessive heat or liquids.
 Danger	• Do not drop the battery or expose to strong shocks or vibrations.
 Danger	• Always store the battery in a cool, dry place.
 Danger	• Do not use the battery if damaged.

Battery Type: AA or 2S Lithium battery (JST port inside battery compartment)

Battery Installation:

1. Open the battery compartment cover.
2. Insert 4 AA batteries with the correct polarity.
 - Select appropriate size 2S 7.4V lithium battery with a JST connector. Make sure it is connected with the correct polarity to avoid damage.
3. Replace battery compartment cover.

3.2 Connecting the Receiver and Servos

Connect the receiver and the servos as indicated below:

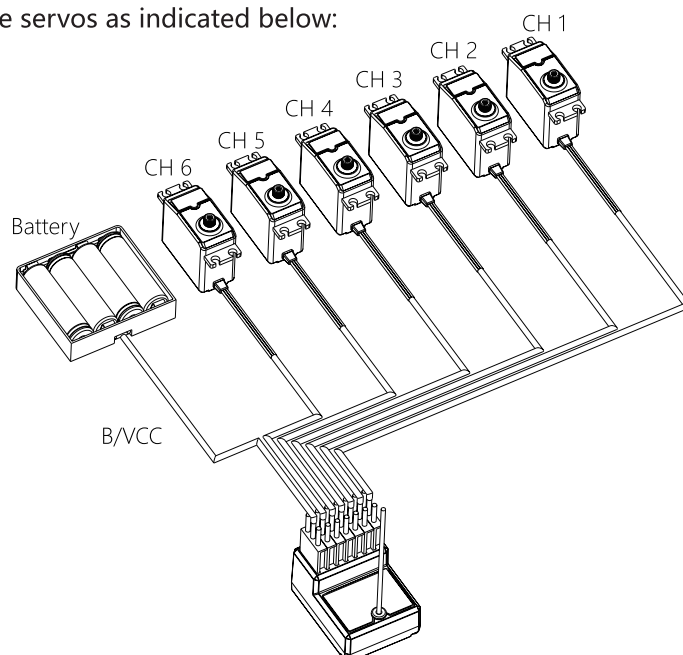

- To ensure the gyroscope works as expected install the receiver horizontally at less than 10 degrees from level.



4. Operation Instructions

After setting up, follow the instructions below to operate the system.

4.1 Power On

Follow the steps below to turn on the transmitter:

1. Make sure that :
 - The battery is fully charged and installed correctly.
 - The receiver is installed correctly and powered down.
2. Move the power switch to the [On] position.
3. Connect the power supply to the receiver.

	Note	• Operate with caution in order to avoid damage or injury.
	Note	• Make sure that the throttle is at its lowest position and the switches are set to their up position.

4.2 Binding

The transmitter and receiver have been pre-bound before delivery.

If you are using another transmitter or receiver, follow the steps below to bind the transmitter and receiver:

1. Connect the bind cable to the receiver's B/VCC port.
2. Connect power to any other port.
3. Press and hold the transmitter's bind key and turn on the transmitter at the same time.
4. Once binding is complete the transmitter will exit bind mode. Remove the power and bind cable from the receiver then apply power to the B/VCC port.
5. Check to make sure everything functions as expected. If not repeat the steps above.

RF Protocol	Compatible Receivers
AFHDS 2A	iA10B , iA6B , iA4B, iA10 , iA6 , iA4C , A6 , A3 , X6B , BS6 , BS4

- This binding information only applies to the FS-GT5 and the FS-BS6 receiver, different receivers may require a different procedure to complete the binding process. Please visit the official FLYSKY website for the latest information on compatible receivers and their respective user manuals.
- All of our products receiver regular updates, please visit our website for more information and firmware downloads.

4.3 Transmitter LED Indicator

If the transmitter voltage is low the LED will flash slowly. This LED has six colors, green, blue, cyan, red, yellow, white and off which can be set according to user preference.

To change the LED color follow the steps below:

1. Hold the BACK key while rotating the Navikey to change the color.
2. Once a color has been selected release the back key.

4.4 Calibration (STK.CAL)

This function is used to calibrate the wheel and trigger.

Setup:

1. To enter the **STK.CAL** function turn and hold the wheel to the right and power on the transmitter.

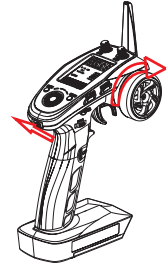

2. Press the Navikey, **STK.CAL** will start to flash to indicate that the function is active, then move the wheel and trigger to their limits in each direction.

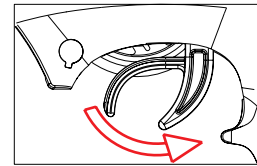
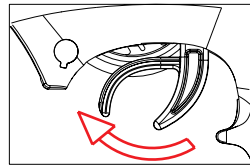
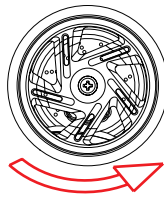
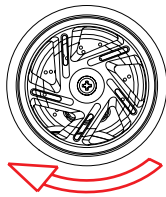

3. When finished press the Navikey to exit the function.
 - If the control surfaces are not moved to their maximum positions the wheel and trigger may not work as expected.

4.5 Factory Reset

Return transmitter settings to factory default. Note: This will delete all model data and settings.

Please follow the steps below to restore factory settings:

1. Turn the wheel counter clockwise and turn on the transmitter, the screen will then display "Reset Default Sure?"
2. Press the Navikey to confirm factory reset. The screen will display "FACY.RST" then start normally.

4.6 Power Off

Follow the steps below to turn off the system:

1. Disconnect the receiver power.
2. Toggle the transmitter's power switch to the off position.

 Danger	<ul style="list-style-type: none">• Make sure to disconnect the receiver power before turning off the transmitter. Failure to do so may lead to damage or serious injury.
---	--

5. System Interface

The main interface mainly displays information related to the model, such as transmitter voltage information, function status and so on.

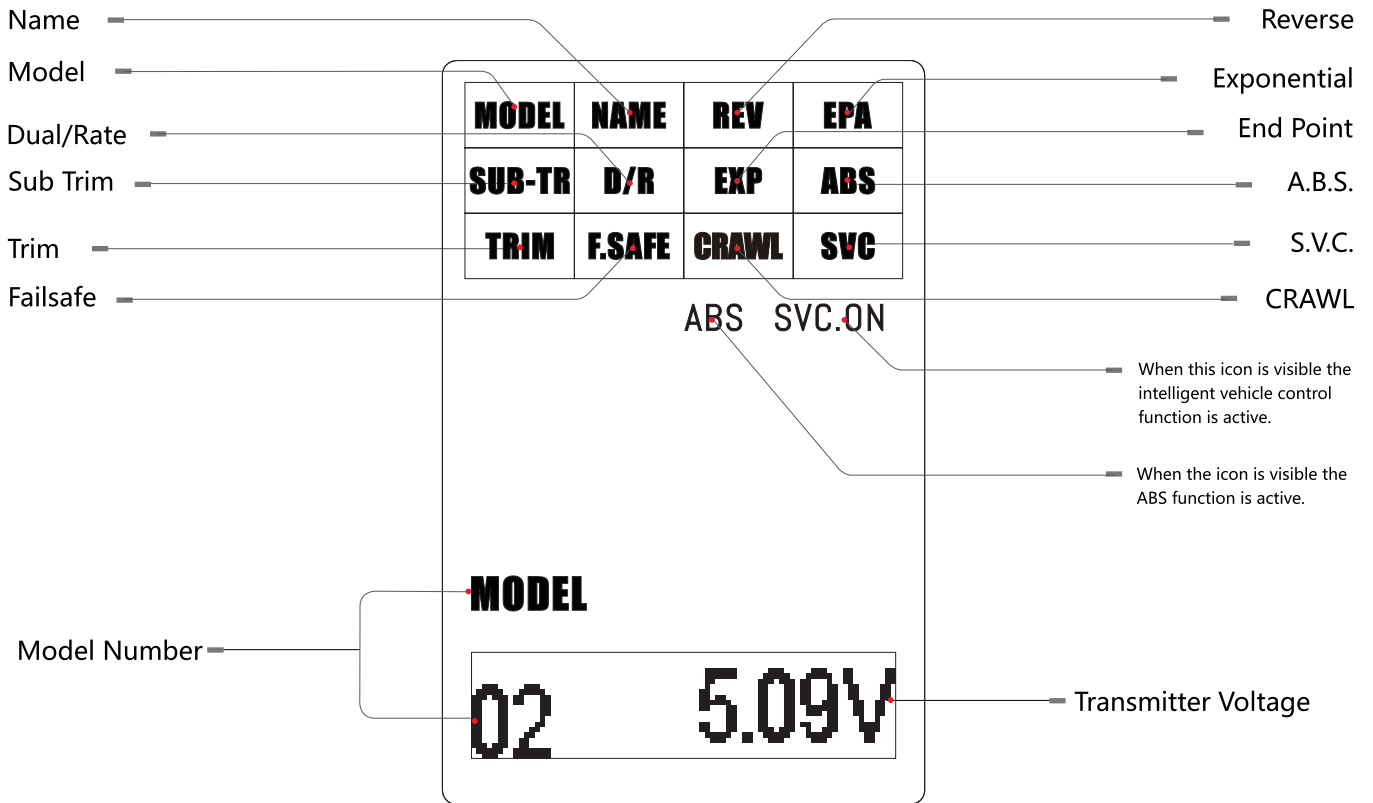

Rotate the Navikey to the left to display model information.

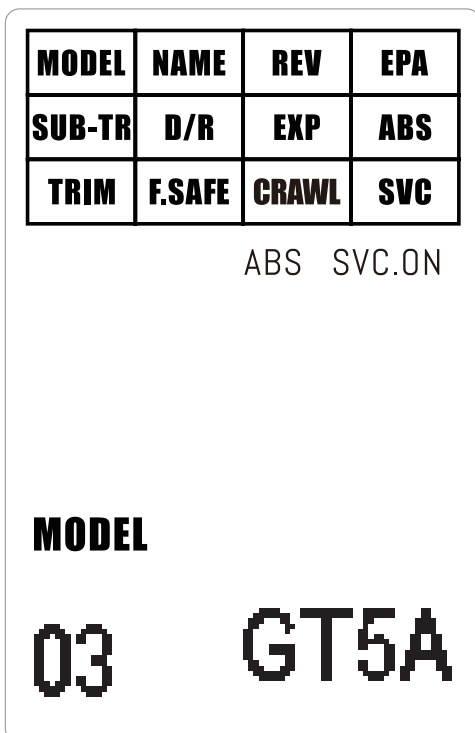

Rotate the Navikey to the right to display channel positions.

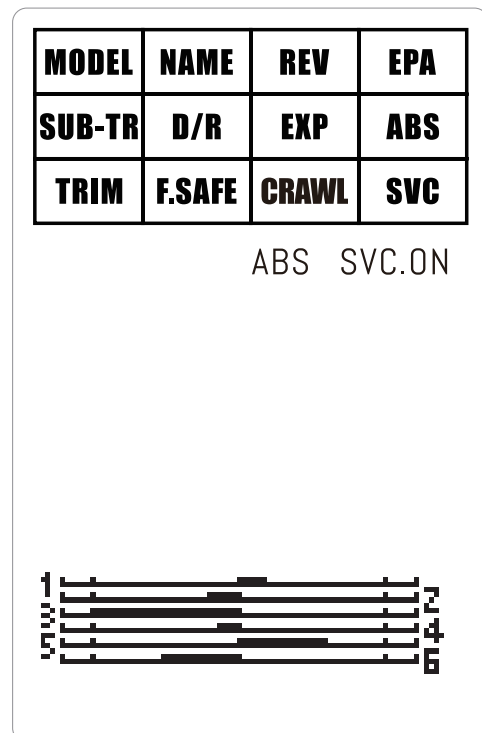

6. Function Settings

This section details functions and their use.

6.1 Model (MODEL)

The transmitter can hold up to 20 models (01-20). Each configuration can quickly be recalled.

Setup:

1. Press the Navkey to enter the function menu, then press the Navkey again to enter the MODEL menu. The model number will begin to flash.
2. Rotate the Navkey to select a model.
3. Press the Navkey to confirm model selection. Once the confirmation is complete the model number will stop flashing.

MODEL	NAME	REV	EPA
SUB-TR	D/R	EXP	ABS
TRIM	F.SAFE	CRAWL	SVC

ABS SVC.ON

MODEL

01 FLY5

6.2 Name (NAME)

This function is for naming a model using up to 4 characters in length : 0123456789 A B C D E F G H I J K L M N O P Q R S T U V W X Y Z

Setup :

1. Press the Navkey to enter the function menu, then rotate the Navkey to select NAME. Press the Navkey again to enter the function. The first letter/number of the model name will begin to flash.
2. Rotate the Navkey to select a character and press the Navkey to confirm the selection.
3. Repeat for the last 3 characters. When the final character has been set the system will exit the function automatically.

MODEL	NAME	REV	EPA
SUB-TR	D/R	EXP	ABS
TRIM	F.SAFE	CRAWL	SVC

ABS SVC.ON

MODEL

01 FLY5

6.3 Reverse (REV)

The reversing function is used to correct the direction of travel for any channel.

Setup :

1. Press the Navkey to enter the function menu, then rotate the Navkey to select REV. Press the Navkey again to enter the function. The channel name and number will begin to flash.
2. Rotate the Navkey to select a channel and press the Navkey to confirm the selection.
3. Rotate the Navkey to select "REV" (reverse) or "NOR" (normal) and press the Navkey to confirm. The system will then exit the function automatically.

MODEL	NAME	REV	EPA
SUB-TR	D/R	EXP	ABS
TRIM	F.SAFE	CRAWL	SVC

ST

1 REV

The channel name will be displayed here as ST, TH or AUX.

6.4 End Point Adjust (EPA)

The EPA function is used to set the travel limits for each channel.

Setup :

1. Press the Navkey to enter the function menu, then rotate the Navkey to select EPA. Press the Navkey again to enter the function. The channel name and number will begin to flash.
2. Rotate the Navkey to select a channel and press the Navkey to confirm the selection.
3. Move the selected channels control surface (wheel trigger etc.) in the direction of the end point you wish to set. The system will display L.F.U (left, front, up) or R.B.D (right, back, down) depending on the selection. Press the Navkey again to confirm.
4. Rotate the Navkey to change the endpoint position (%) and press the Navkey to confirm.
5. Repeat as needed.

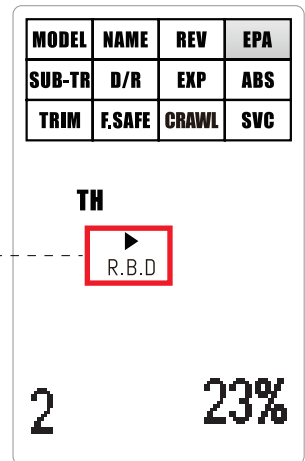

Depending on the end point selected the system will display [R.B.D] or [L.F.U].

6.5 Sub Trim (SUB-TR)

This function can be used to change the centre point of any channel.

Example of use: to correct steering being out of alignment even if the transmitter wheel is centered.

1. Press the Navkey to enter the function menu, then rotate the Navkey to select SUB-TR. Press the Navkey again to enter the function. The channel name and number will begin to flash.
2. Rotate the Navkey to select a channel and press the Navkey to confirm the selection.
3. Rotate the Navkey to change the channel's center point. The system will display an L (left) or R (right) depending on which direction the center point has been moved. Press the Navkey to confirm.
4. Repeat as needed.

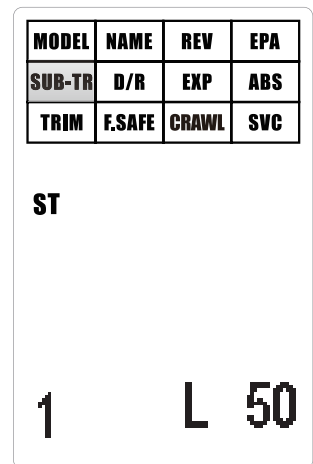

6.6 Dual/Rate (D/R)

This function is used to limit the ST or TH D/R.

Setup :

1. Press the Navkey to enter the function menu, then rotate the Navkey to select D/R. Press the Navkey again to enter the function. The channel name and number will begin to flash.
2. Rotate the Navkey to select a channel and press the Navkey to confirm the selection.
3. Rotate the Navkey to change the D/R value (%) and press the Navkey to confirm.

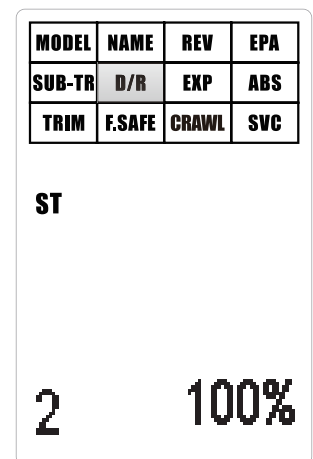

6.7 Exponential (EXP)

This function is used to add a curve to the output of a channel. When set to 0 the curve response is linear, however when set to a positive or negative value the curve will no longer be linear.

Setup :

This function can adjust the throttle's response curve from -100%~100%.

1. Use the NaviKey to select the **[EXP]** menu , press the Navikey to enter the menu.
2. **[EXP]** will start flashing. Use the NaviKey to select **[ST]**, **[TH]** (R.B.D if trigger pushed) or **[TH]**(L.F.U if trigger pulled).
3. Press the Navikey then use the NaviKey to change the percentage.
4. Press the Navikey again to confirm.
5. Repeat for other channels as needed.

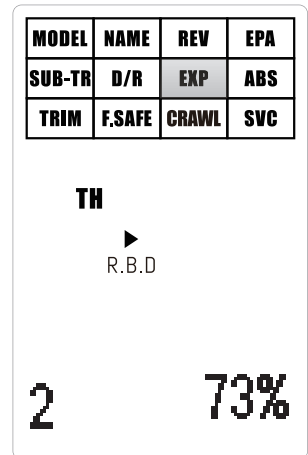

6.8 A.B.S. (ABS)

This function uses the throttle output to create automatic braking in order to make braking easier on different surfaces.

Setup:

This function only adjusts the throttle channel. There are 6 settings:

[BRK]: The amount of breaking applied for each pulse.

[DLY]: Amount of delay between the trigger being pushed and ABS becoming active.

[CYC]: The interval between each pulse. The larger the value, the longer the pulse interval.

[TGP]: Sets the trigger position that will activate the ABS function.

[DTY]: Changes the ratio between brake on and break off time. When this value is changed the square wave controlling the brakes will no longer be symmetrical.

[STM]: Creates a mix between the steering and the ABS function so that ABS can be automatically decreased or disabled when turning. The % sets the point in which the steering will have to be turned in order to activate this function with a range between 0-100%. E means the function will not activate until the trigger moves beyond that percentage, N means the breaking will be disabled until it reaches that percentage.

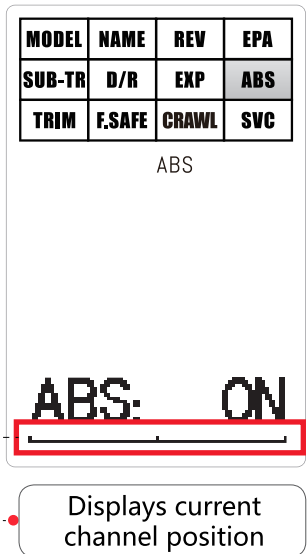

Funt.	Range	Default	Display
[BRK]	0~100%	50%	BRK: 50%
[DLY]	0~100%	0	DLY: 0%
[CYC]	20%~100%	50%	CYC: 50%
[TGP]	10%~100%	30%	TGP: 30%
[DTY]	-4~4	0	DTY: 0
[STM]	E10%~100% N10%~100%	OFF	STM: OFF

Setup :

1. Press the Navikey to enter the function menu, then rotate the Navikey to select **ABS**. Press the Navikey again to enter the function. **ABS** will begin to flash at the bottom of the screen. (This function needs to be active to use. Press the NaviKey when **ABS** is flashing and rotate the Navikey to turn it on, then press the NaviKey to confirm and repeat step 1.)
2. Rotate the Navikey to select an ABS function and press the Navikey to confirm the selection.
3. Rotate the Navikey to change the function value and press the Navikey to confirm.
4. Repeat as needed.

6.9 Trim (TRIM)

This function is used to change the center point of each channel. For example if the steering wheel, when centered, leaves the model's wheels pointing out of alignment, this function can be used to correct it.

Setup:

This function can be used to adjust 4 channels: steering, throttle, channel 3 and channel 4. The adjustment range is between 0-120. Adjustments may also be made on the fly using the trim buttons. The direction from the centre will be represented as L (left) or R (right) for steering, F (forward) or B (back) for throttle and U (up) or D (down) for AUX 3 and 4.

1. Use the NaviKey to select the **[TRIM]** menu, press the Navikey to edit the function.
2. **[ST]** will flash. Use the NaviKey to select a channel, then press the Navikey.
3. With a channel selected use the NaviKey to change the percentage.
4. Press the Navikey to save and exit.
5. Repeat for other channels as needed.

6.10 Failsafe (F.SAFE)

This function protects the model, the safety of the user and others. When active the failsafe will set all channels to a predefined value until either, power is removed or it regains signal. If a channel is set to off it will remain in the last position it was in when signal is lost.

Setup :

This function only works with 6 channels with an adjustment range from -100-100%.

1. Use the NaviKey to select the **[F.SAFE]** menu, then press the Navikey to enter the function.
2. The screen will display **[ST]** and **[OFF]**. Rotate the Navikey to select a channel then press the navikey to confirm.
3. Move the selected channel to the desired position using its control input and press the Navikey to save.
4. Repeat for other channels as needed.

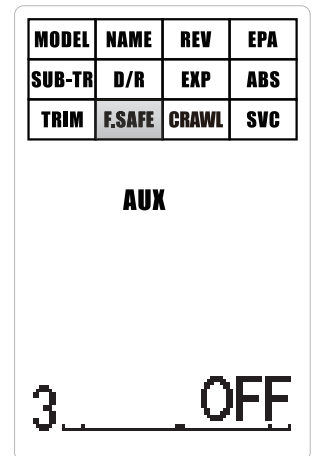
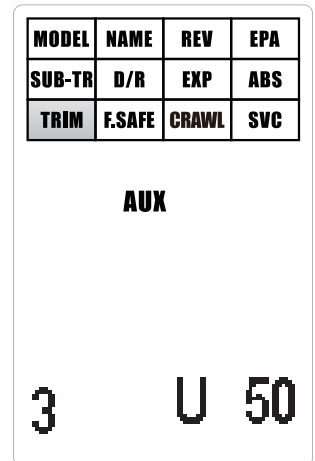

6.11 Crawl (CRAW)

This function is used to create a crawler mix, meaning that the front and back wheels can move in different directions. By default this function is set to off. Channel 3 will always be assigned as the rear wheels.

Setup :

[A]: Front wheel steering.

[B]: Rear wheel steering.

[C]: The front and back wheels will turn in the same direction for tight turns.

[D]: Front and back wheels will move in opposite directions.

1. Use the NaviKey to select the [CRAW] menu, press the Navikey again to enter the function.
2. Use the NaviKey to choose [A]~[D] or OFF.
3. Press the Navikey to confirm selection.

The following table shows the available modes:

[A]	A:	I	[C]	C:	I
[B]	B:	I	[D]	D:	I

6.12 S.V.C. (SVC)

Note: This function is only available for the FS-BS6. However because of frequent updates this function may become available for other receivers. for more information please visit our website.

Intelligent vehicle control needs the use of the receivers gyroscope. Using the gyroscope this function will alter throttle and steering in order to keep the model going in the desired direction.

Neu.Cal(Neutral Calibration)

Calibrates the gyro settings so that the intelligent vehicle control system is able to set a current position for the netrual steering position.

This calibration will happen each time the steering returns to this position in order for the system to detect any direction change that is not desired by the user.

Rev (reverse)

Changes the direction in which the function will correct the steering. To test, lift the model up and rotate it left and right to make sure the correction is applied in the correct direction. When rotated to the left the models front wheels should turn to the right and vice versa.

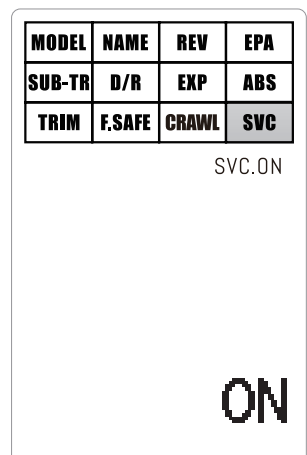
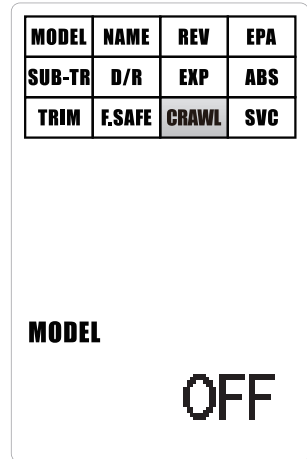

St.Gain (direction sensitivity)

Changes the amount of automatic steering correction that will take place when the model changes direction unexpectedly, usually due to terrain or surfaces that are slippery. This function has a range of 0-100%, 0% being no correction and 100% being the maximum amount of correction.

If the model swerves from side to side when driving reduce the amount of St.gain.

Th.Gain (throttle sensitivity)

Changes the amount of throttle reduction during cornering that will take place when the function is active. This function has a range of 0-100%, 0% being no throttle reduction and 100% being the maximum amount of throttle reduction.

Prio (priority)

Priority is used to set the control ratio between the GT5' s wheel and the gyroscope when the vehicle is turning. When the GT5' s wheel is turned, the steering angle will be reduced, depending on speed, due to the mixed control with the gyroscope. When set to 0% the gyro mix will have the most effect resulting in larger turning circles, when set to 100% the GT5' s wheel will have the highest priority overriding any correction coming from the gyroscope.

Setup: **[MODE: ON/OFF]**

On/Off

1. Use the NaviKey to select the **[SVC]** menu, press the Navikey again to enter the function.
2. Move the Navikey to select SVC.ON, then rotate the Navikey so that the function shows "ON" in the bottom right corner.
3. Press the Navikey again to confirm.

[Neu.Cal]

1. Use the NaviKey to select the **[SVC]** menu, press the Navikey again to enter the function.
2. Rotate the Navikey to select **Neu.Cal**.
3. Make sure everything is centered and press the Navikey again to start calibration.

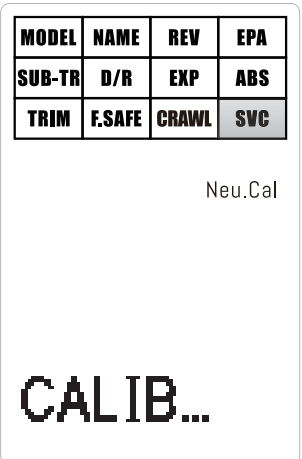

[Rev]

1. Use the NaviKey to select the **[SVC]** menu, press the Navikey again to enter the function.
2. Rotate the Navikey to select **Reverse** and press the Navikey to confirm.
3. Rotate the Navikey to change between **NOR** (Normal) and **REV** (Reverse) as required.
4. Press the Navikey to confirm.

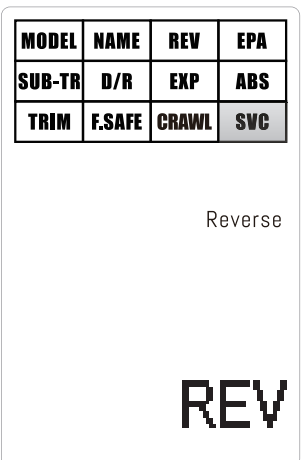

[St.Gain]

1. Use the NaviKey to select the **St.Gain** menu, press the Navikey again to enter the function.
2. Rotate the Navikey to change the **St.Gain** value (%).
3. Press the Navikey to confirm.



[Th.Gain]

1. Use the NaviKey to select the **Th.Gain** and press the Navikey to confirm.
2. Rotate the Navikey to change the **Th.Gain** value (%).
3. Press the Navikey to confirm.

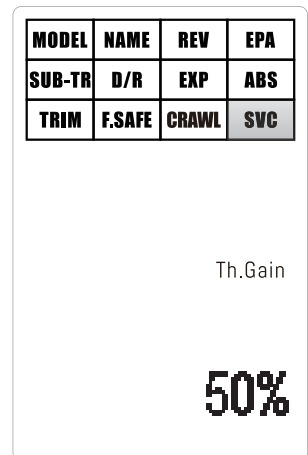

[Priority]

1. Use the NaviKey to select the **Th.Gain** and press the Navikey to confirm.
2. Rotate the Navikey to change the **Th.Gain** value (%).
3. Press the Navikey to confirm.

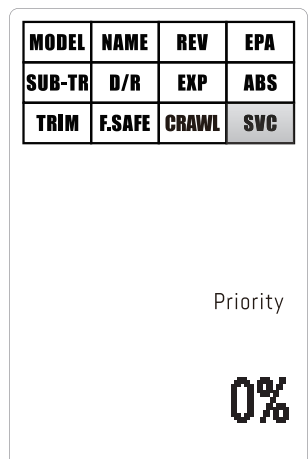

7. Product Specifications

This section contains FS-GT5 transmitter and FS-BS6 receiver specifications.

7.1 Transmitter specification(FS-GT5)

Model Type	Car, Boat
Channels	6
RF Range	2.408-2.475 GHz
Bandwidth	500KHz
Bands	135
RF Power	<20dBm (for Europe)
Receiving Sensitivity	-95dBm
2.4GHz Protocol	AFHDS 2A
Modulation Type	GFSK
Transfer Method	FHSS
Channel Resolution	4096
Channel Delay	< 15ms
Low Voltage Alarm	AA batteries <4.4V, 2S lithium battery <7.4V
Data Output	None
Charging Port	None
Antenna	26mm
Input Power	None
Display	NTN semi-permeable, segment screen, VA52.5 * 34mm LCD white backlight
Online Update	N/A
Range (No ground interference)	> 200m
Working Current	100 ~120mA
Channel Data Parameters	Median: 1500us, Range: 900 ~ 2100us
Dimensions	158*95*243 mm
Weight	296g
Certification	CE, FCC ID : N4ZGT500



7.2 Receiver Specification(FS-BS6)

The FS-BS6 has a built-in gyroscope stabilization system.

Channels	6
RF range	2.408-2.475 GHz
RF channel	135
RX sensitivity	-95dBm
2.4GHz system	AFHDS 2A
RF Power	<20dBm (for Europe)
Modulation type	GFSK
Power input	4.0 - 8.4 V DC
Weight	7.65g
Dimensions	29mm x 22mm x 16 mm
Certificate	CE, FCC ID : N4ZBS600

Digital Proportional Radio Control System **FS-GT5**

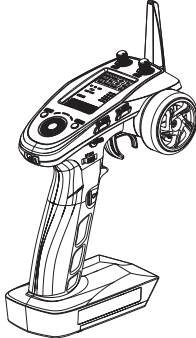
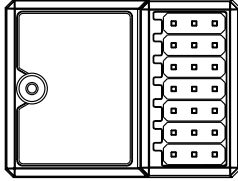
8. Package Contents

Item	Quantity	
Transmitter FS-GT5	1	
Receiver FS-BS6	1	
Quick Start Guide	1	

9. Certification

9.1 DoC Declaration

Hereby, [Flysky Technology co., ltd] declares that the Radio Equipment [FS-GT5] is in compliance with RED 2014/53/EU.

The full text of the EU DoC is available at the following internet address: www.flysky-cn.com

9.2 CE Warning

The antenna(s) used for this transmitter must be installed to provide a separation distance of at least 20 cm from all persons and must not be co-located or operating in conjunction with any other transmitter. End-users and installers must be provided with antenna installation instructions and transmitter operating conditions for satisfying RF exposure compliance

9.3 Appendix 1 FCC Statement

This equipment has been tested and found to comply with the limits for a Class B digital device pursuant to part 15 of the FCC rules. These limits are designed to provide reasonable protection against harmful interference in a residential installation. This equipment generates, uses and can radiate radio frequency energy and, if not installed and used in accordance with the instructions, may cause harmful interference to radio communications. However, there is no guarantee that interference will not occur in a particular installation. If this equipment does cause harmful interference to radio or television reception, which can be determined by turning the equipment off and on, the user is encouraged to try to correct the interference by one or more of the following measures:

Reorient or relocate the receiving antenna.

Increase the separation between the equipment and receiver.

Connect the equipment into an outlet on a circuit different from that to which the receiver is connected.

Consult the dealer or an experienced radio/TV technician for help.

To assure continued compliance, any changes or modifications not expressly approved by the party responsible for compliance could void the user's authority to operate this equipment.

This equipment complies with Part 15 of the FCC Rules. Operation is subject to the following two conditions:

- (1) This device may not cause harmful interference, and
- (2) This device must accept any interference received, including interference that may cause undesired operation.

Caution!

The manufacturer is not responsible for any radio or TV interference caused by unauthorized modifications to this equipment. Such modifications could void the user authority to operate the equipment.

1. Move all your channels to the desired position.
2. Select [All channels] and then [Yes] in the confirmation box.

10. Environmentally friendly disposal

Old electrical appliances must not be disposed of together with the residual waste, but have to be disposed of separately. The disposal at the communal collecting point via private persons is for free. The owner of old appliances is responsible to bring the appliances to these collecting points or to similar collection points. With this little personal effort, you contribute to recycle valuable raw materials and the treatment of toxic substances.

CAUTION

RISK OF EXPLOSION IF BATTERY IS REPLACED BY AN INCORRECT TYPE.
DISPOSE OF USED BATTERIES ACCORDING TO THE INSTRUCTIONS

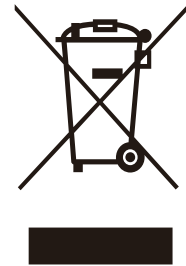



www.flysky-cn.com

Copyright ©2017-2018 Flysky Technology co., ltd

Release date: 2017-09-19



FCC ID: N4ZGT500